

WHO/CDS/WHOPES/GCDPP/2000.3 Rev.1
English only
Distr.: General

**MANUAL FOR INDOOR
RESIDUAL SPRAYING**

**APPLICATION OF
RESIDUAL SPRAYS FOR
VECTOR CONTROL**



**World Health Organization
Communicable Disease Control,
Prevention and Eradication
WHO Pesticide Evaluation Scheme**

©2002 World Health Organization.

This document is not a formal publication of the World Health Organization (WHO) but all rights are reserved by the Organization. The document may, however, be freely reviewed, abstracted, reproduced and translated, in part or in whole, but not for sale or for use in conjunction with any commercial purposes.

Contents

	Page
Preface	2
Acknowledgements	4
1. Objective	5
2. Safety	6
3. Protective clothing	11
4. Preparations – <i>The household</i>	12
5. Preparations – <i>Equipment</i>	14
6. Mixing, handling and spray techniques	23
7. Procedures after spraying	29
8. Disposal of remains of insecticides and empty packaging	31
9. Maintenance of equipment	34
10. Trouble-shooting	42
11. Preparation of insecticide spray	47

Preface

The WHO specifications for public health pesticides are part of the International Code of Conduct on the Distribution and Use of pesticides, and are used for quality control and international trade.

The WHO Pesticide Evaluation Scheme (WHOPES) develops specifications for public health pesticides once they have been fully tested for their safety and efficacy in the laboratory and in the field.

WHOPES promotes the safe, judicious and proper use of pesticides, including their safe and proper application. Such application relies mainly on the quality and working conditions of the equipment, as well as the skills and knowledge of the operators using the equipment. WHOPES has developed and published specifications for pesticide application equipment for vector control, to provide the minimum standards and requirements for safe and proper performance.

Indoor residual spraying is extensively used, especially for malaria and Chagas vector control. However, both vector control programmes frequently lack well trained field staff to apply the insecticides and maintain the application equipment. With good skills and quality application equipment hazards to human health and the environment, as well as financial losses can be avoided.

This manual is intended to serve as a “model” for developing relevant training manuals and procedures at country level, to ensure safe and effective use of insecticides in vector control programmes.

In the original document working tank-pressure of 70 psi was recommended to overcome one of the major operational problems of spraying in the field, i.e., the

unreliability of pressure gauges; the untimely re-pumping of the tanks, and the formation of large spray droplets which would easily fall on the ground, rather than on the intended wall surface. Nevertheless, it has become clear that with a higher initial tank-pressure and consequent changes in output at the nozzle, the speed at which the nozzle is moved by the operator would need to be modified to achieve the recommended dosage. This is not easy to achieve so the recommendations are now updated to help users obtain a more uniform deposition of insecticide.

It is strongly recommended that users fit a “control flow valves (CFV)” to the nozzle to ensure more uniform output of spray. The valve will open provided the tank pressure exceeds that of the valve setting. Where a CFV is not fitted, the user can revert to a working tank-pressure of 55 psi (3.8 bar).

The revised document also contains easy-to follow steps in preparation of insecticide sprays.

Acknowledgements

The WHO Department of Communicable Disease Control, Prevention and Eradication (CPE) wishes to thank the following for their valuable technical contributions in the development of this manual:

- Dr J. I. Arredondo Jimenez, Centro de Investigacion de Paludismo, Chiapas, Mexico
- Dr P. Carnevale, Institut Pierre Richet, Bouake, Côte d'Ivoire
- Dr E. Chadd, Zeneca, Fernhurst, UK
- Dr C. Frederickson, Pan American Health Organization, Brasilia, Brazil
- Dr P. Guillet, CPE/PVC, WHO, Geneva, Switzerland
- Mr R. C. Hudson, Jr., H. D. Hudson Manufacturing Company, Chicago, Illinois, U.S.A.
- Professor G. Matthews, International Pesticides Application Research Centre, Ascot, UK
- Dr S. Nalim, National Institute for Vector Control Research, Salatiga, Indonesia
- Dr M. Nathan, CPE/PVC, WHO, Geneva, Switzerland
- Dr A. M. Oliveira-Filho, Universidade Federal do Rio de Janeiro, Brazil
- Dr C. Schofield, St. Jenis, France
- Dr V. P. Sharma, Malaria Research Centre, Delhi, India
- Dr M. Zaim, CPE/PVC/WHOPES, WHO, Geneva, Switzerland

CPE also wishes to thank H. D. Hudson Manufacturing Company, especially Mr J. M. Hepburn, for their kind assistance in preparation of the drawings.

This publication has been funded by the Global Collaboration for Development of Pesticides for Public Health (GCDPP).

1. Objective

To ensure the safe and correct application of a residual insecticide to indoor surfaces on which malaria vectors may rest.

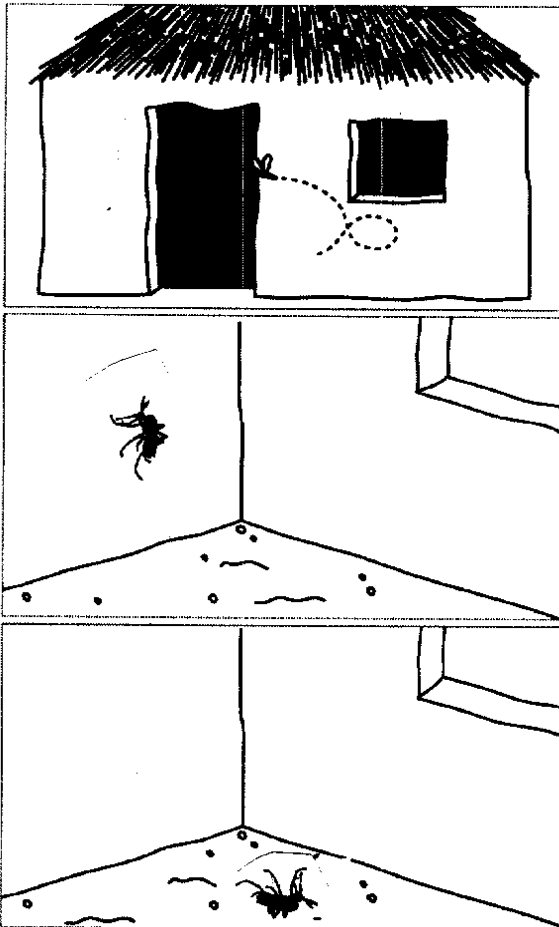

2. Safety

Exposure to insecticides may occur when handling and spraying insecticides as follows:

- When handling the insecticide product during opening of the package, mixing and preparation of the spray.



- When spraying the insecticide, especially in high places.

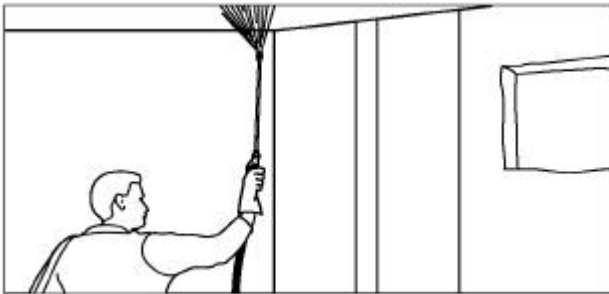

Safety precautions:

- Do not eat, drink or smoke while working.

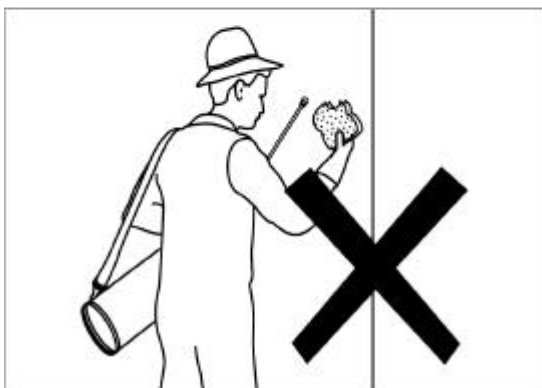
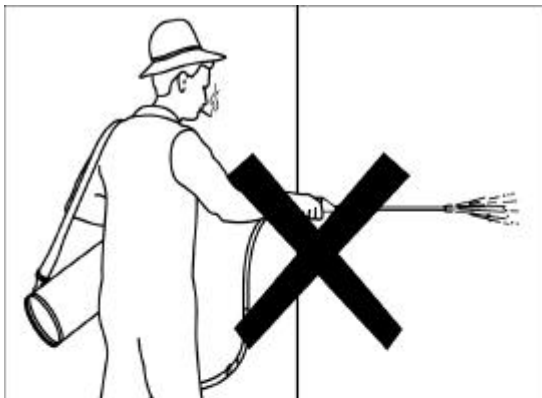

- Wash your hands and face with soap and water after spraying and before eating, smoking or drinking.

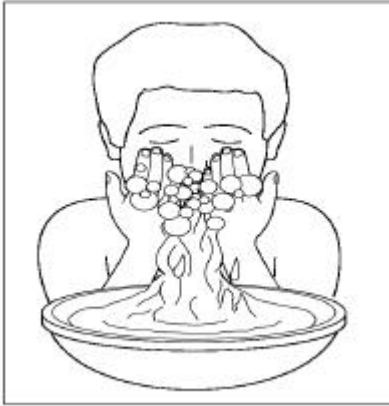

- Shower or bathe at the end of every day's work and change into clean clothes.

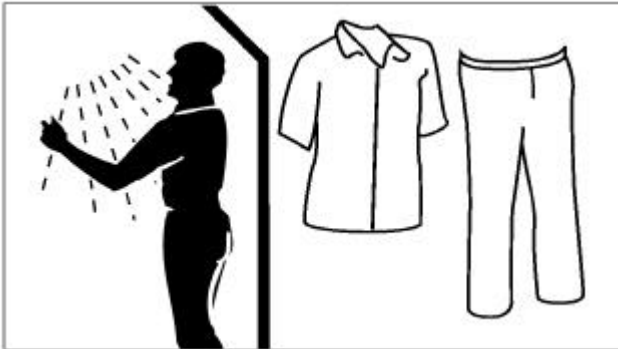

- Wash your overalls and other protective clothing at the end of each working day in soap and water and keep them separate from the rest of the family's clothes.

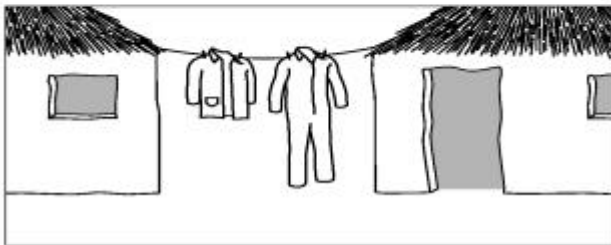
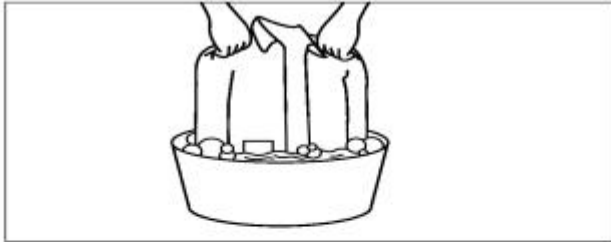

- If the insecticide gets on your skin, wash off immediately with soap and water.

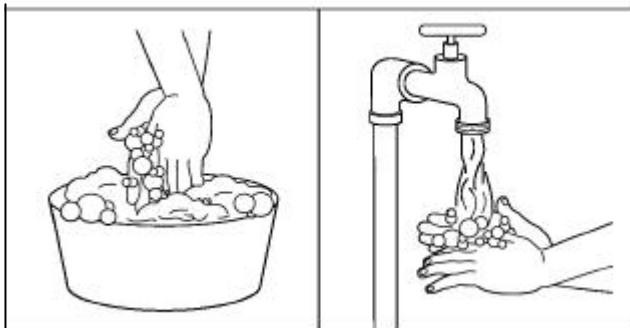

- Change your clothes immediately if they become contaminated with insecticides.

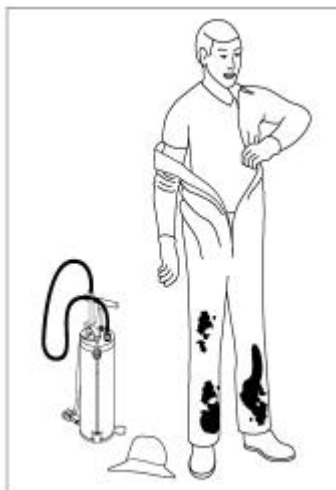

- Inform your supervisor immediately, if you do not feel well.



3. Protective clothing

Absorption of insecticide occurs mainly through the skin, lungs and mouth. Specific protective clothing must be worn in accordance with the safety instructions on the product label.

- A. Broad rim hat (protects head, face and neck from spray droplets)
- B. Goggles or face shield (protects face and eyes against spray fall-out.)
- C. Face mask (protects nose and mouth from airborne particles of the spray fall-out.)
- D. Long sleeved overalls. (Keep overalls outside of boots.)
- E. Rubber gloves.
- F. Boots.

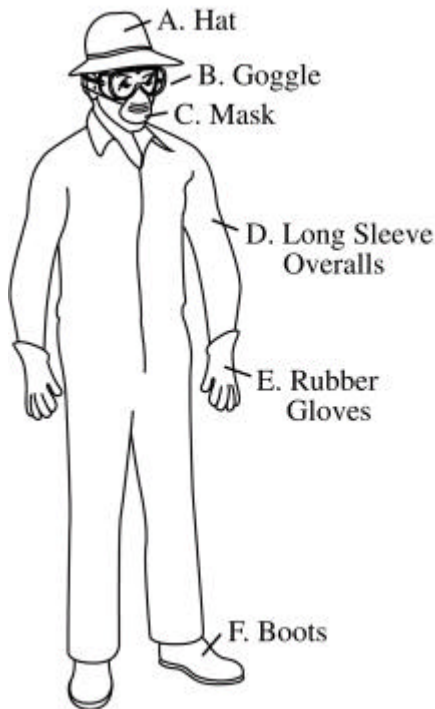

4. Preparations – *The household*

Inform the householder of the spraying schedule and the purpose of spraying, giving them time to prepare and vacate the house.

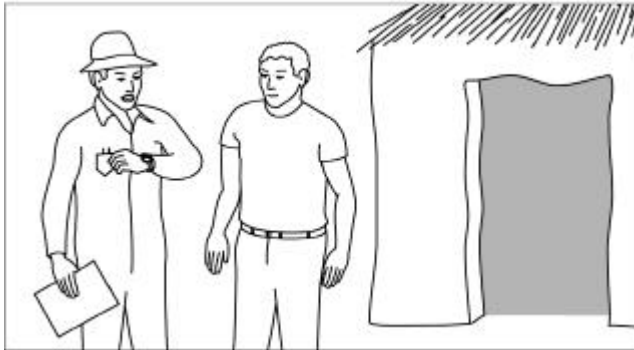

Occupants **MUST** leave houses before spraying. Rooms occupied by sick people who cannot be moved must **NOT** be sprayed.



Remove all household items, including water, food, cooking utensils and toys from the house. Move and cover, or take out the furniture to allow easy access for spraying walls. Items that can not be removed should be well covered.



Cage or tether pets and domestic animals away from the house.



5. Preparations - *Equipment*

Indoor residual spraying of insecticides is normally done using hand-operated compression sprayers. Before starting a spray operation, the equipment must be checked. Faulty sprayers may result in poor control or over-treatment.

Examine the sprayer visually to ensure that all parts are present, assembled correctly and are in good condition.

- A. Sprayer tank
- B. Shoulder strap
- C. Lid
- D. Pump (handle)
- E. Pressure gauge
- F. Lance
- G. Strainer
- H. Hose
- I. Nozzle – check correct type of nozzle is fitted and is not damaged or worn (flat fan nozzle with 80° swath and 0.76 l/min flow rate at 40 psi).
- J. Trigger on/off valve. Is the strainer inside valve handle clean?
- K. Footrest

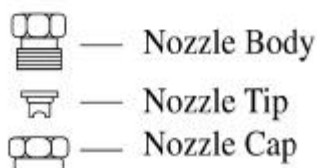
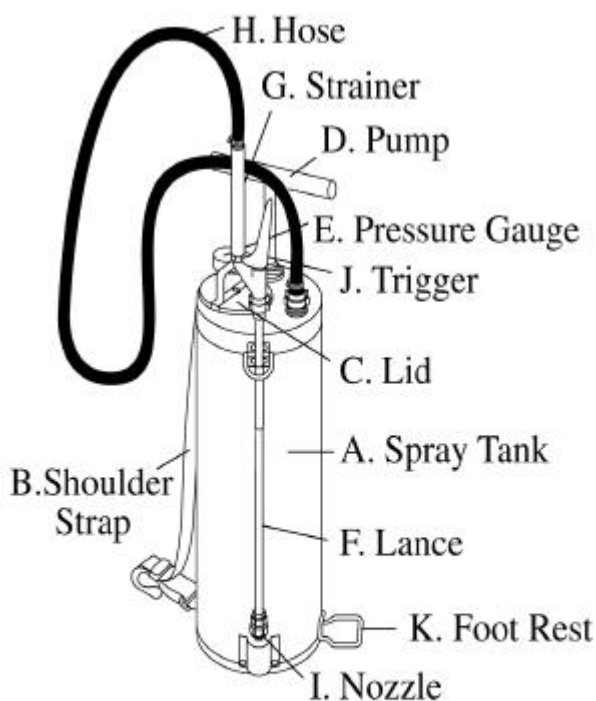

Before using an insecticide use clean water to ensure that the equipment operates properly and does not leak. Wear protective clothing. To check, follow the steps below:

- Pour clean water into the tank (never fill tank more than 3/4 full).

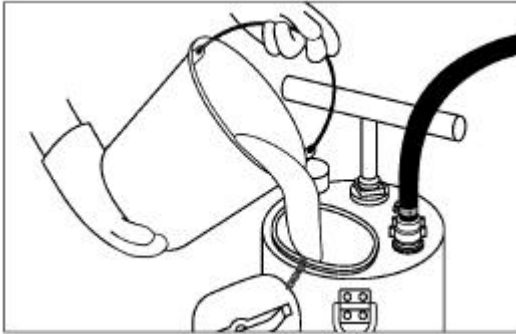

- Fit the lid. Turn the handle to lock the lid in position.

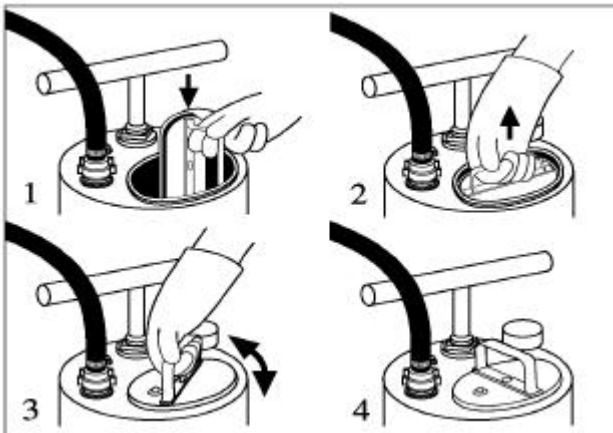

- Operate the pump using both hands and with foot on the footrest. Pump to the working pressure 55 psi (3.8 bar). Every full stroke gives about 1 psi.

Note: 1 bar = 100 millibar = 14.5 psi = 100 kpa.

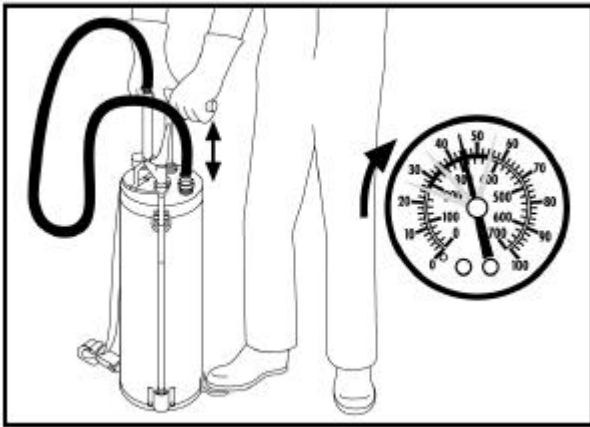

- Check tank is holding pressure. Listen for hissing sound of escaping air.

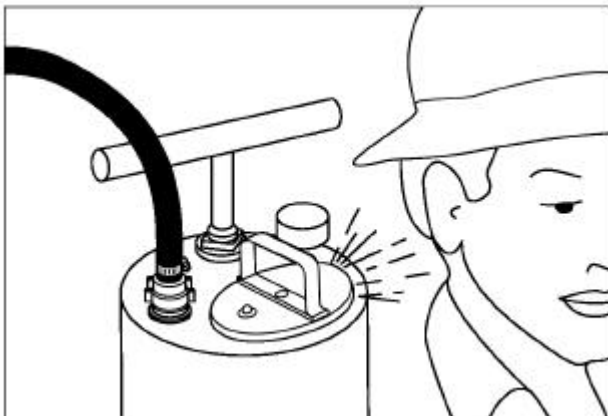

- Does pressure gauge show an increase in pressure as you pump?

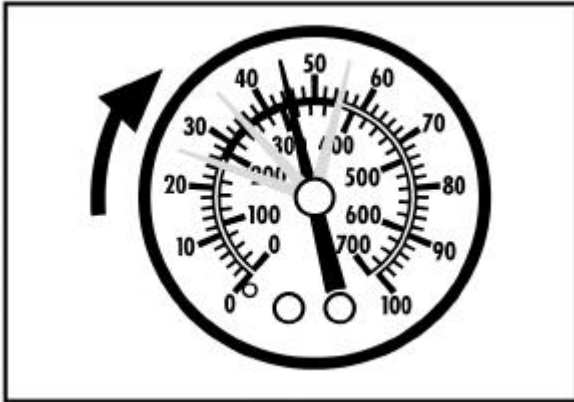

- Check to make sure there are no leaks along lance and hose, especially where hose joins tank and trigger on/off valve.

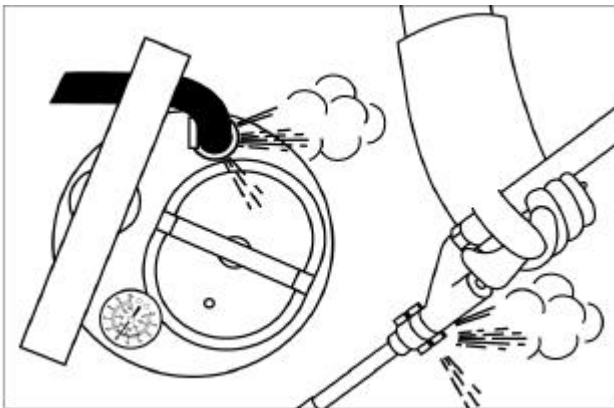

- Operate trigger on/off valve to make sure that spray is emitted from the nozzle.

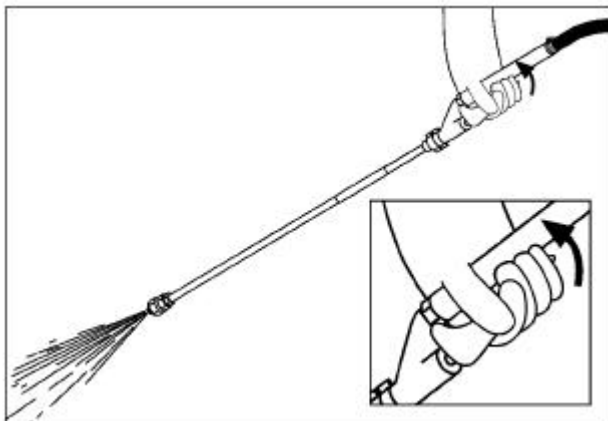

- Check the spray pattern from the nozzle by spraying a dry wall surface. Look to see that the pattern is even and without streaks. Ensure nozzle does not drip when trigger on-off valve is released.



- Calibrate the nozzle with water in the tank. Pump to 55 psi (3.8 bar). Open the trigger on-off valve for one minute, collect the discharge and measure the amount in a measuring jug. Empty the jug. Discharge for a further one minute and measure the amount. Repeat for a 3rd discharge. Calculate the average of the three, one-minute measurements.



- With the above procedure, the average discharge of a 8002 nozzle is about 760 ml per minute. If the discharge is incorrect (760 ± 15 ml/minute), check the nozzle and the screen filters to ensure they are not clogged. If necessary replace nozzle. Repeat the calibration. The addition of a constant flow valve set on the lance will ensure that the flow rate does not decrease as the pressure in the tank falls.

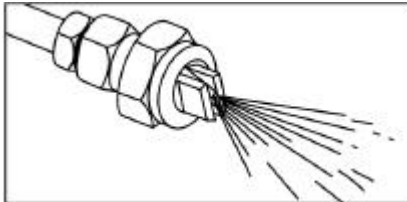

If the nozzle is clogged:

The opening in a nozzle is very small and must not be damaged. Clogged nozzles should be put in a container with water for several hours before the blockage is removed by a very soft toothbrush. NEVER clean nozzle with a hard pin or piece of wire and NEVER put a nozzle to your mouth to blow through it.



Having checked the sprayer, de-pressurise by rotating the lid handle so that it stops on top of the pressure release button valve on top of the lid. During this process, hold the handle to prevent the lid from falling into the tank. Empty out the clean water you have used for testing the sprayer.

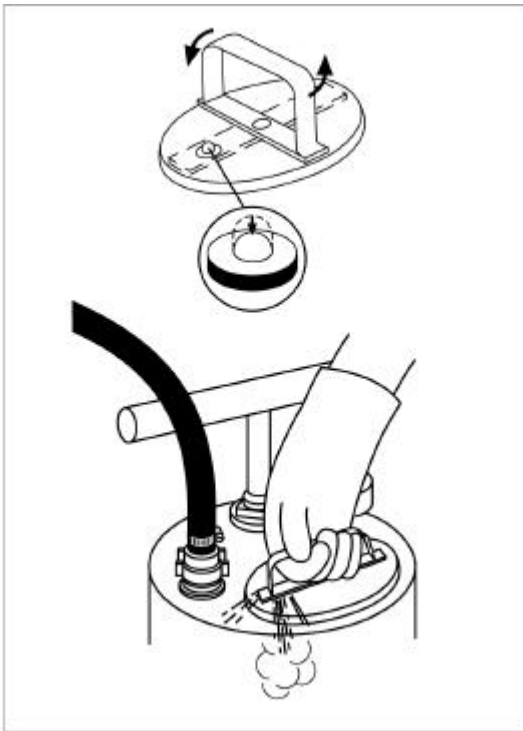

6. Mixing, handling and spray techniques

Prepare the insecticide spray according to the manufacturer's instructions. The insecticide may be mixed separately in a bucket and poured into the sprayer (see section 11).

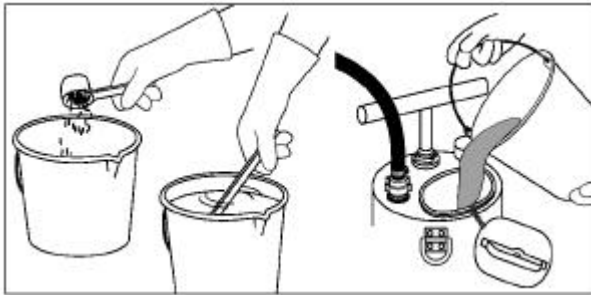

Water soluble sachets, tablets and insecticides granules are added directly to the water filled tank. These formulations mix readily with water and reduce the hazards associated with handling and mixing in a separate container.

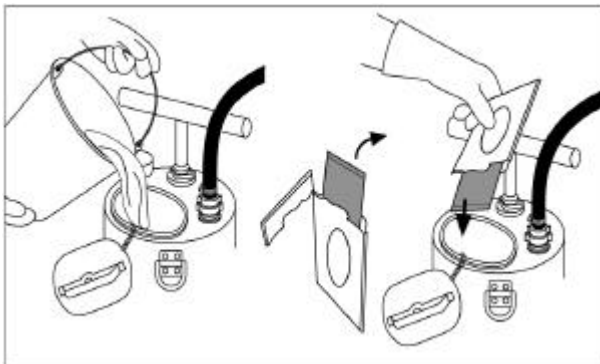

When the sprayer has been filled with water to the maximum level indicated on the tank, the lid of the tank is fitted and the sprayer pumped until the pressure gauge shows 55 psi (3.8 bar). Every full stroke gives about 1 psi. About 55 full strokes are required to reach the working pressure.

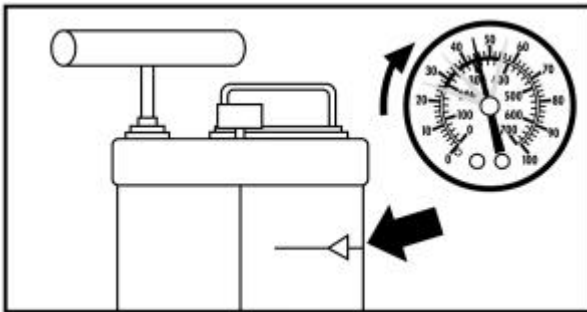

The contents of the tank should be thoroughly mixed by shaking the tank before starting to spray.

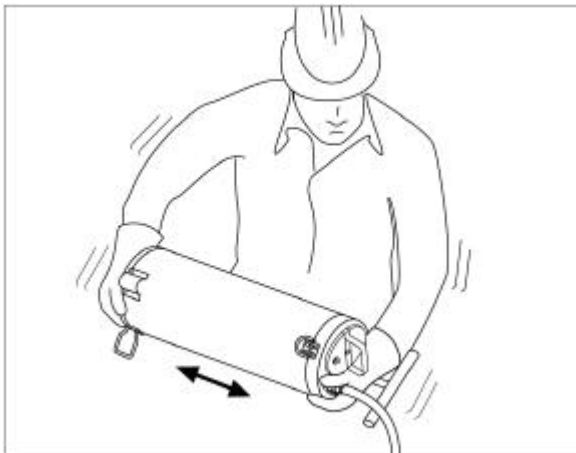

Spray is applied in vertical swaths 75 cm wide. Swaths should overlap by 5 cm. Spray from roof to floor, using a downward motion, to complete one swath. Step sideways and spray upwards from floor to roof.



To ensure the correct swath width, keep the spray tip about 45 cm from the wall. Lean forwards as you spray from top of the wall and move back as you bring the nozzle downwards. Continue the procedure, moving in a clockwise direction until the room is completed.

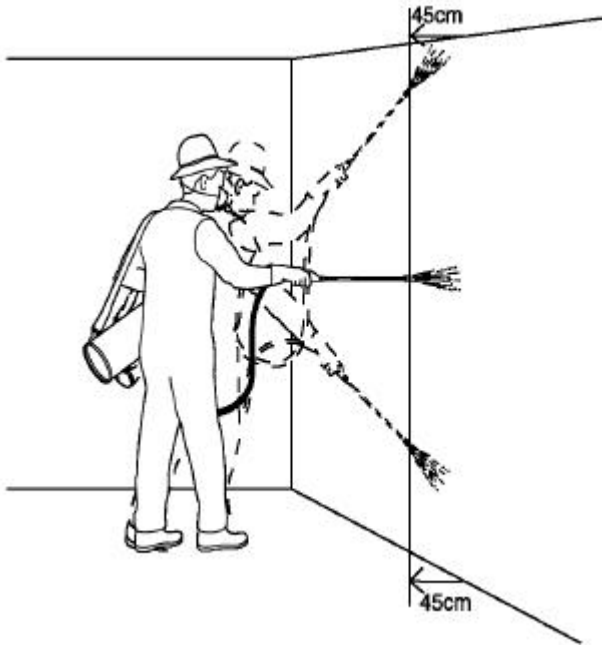

Time your spray speed to cover one meter every 2.2 seconds, i.e., 4.5 seconds for a 2 m high wall. Timing may be aided by mentally counting “one thousand and one – one thousand and two – one thousand and three -...”. Adjust the mental counting procedure according to the local language.

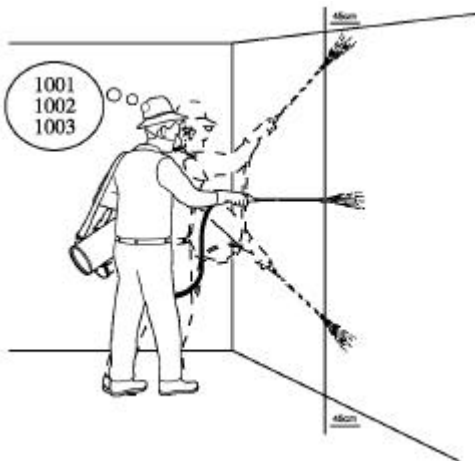

If spray stops due to a blockage in nozzle, unscrew the nozzle cap, remove blocked nozzle and replace with a new one. The blocked nozzle should be cleaned as explained above. Do not let spray drip on the floor.

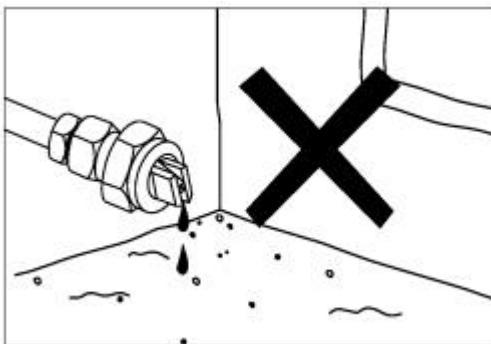

Re-pressurize the tank when the pressure gauge falls below 25 psi.

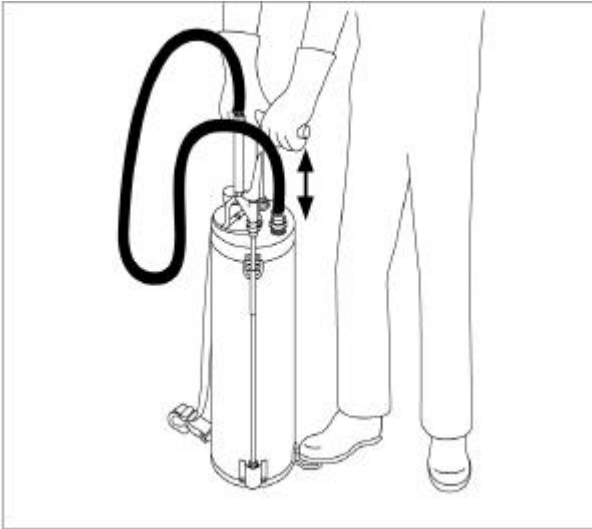

The use of “control flow valve (CFV)” is recommended as it will reduce the need for re-pumping and will produce a uniform discharge rate ensuring that a uniform amount of insecticide is placed on wall. The valve is fitted by first removing the nozzle body. Fit a washer into the end of the CFV that is then screwed to the nozzle body. The nozzle tip and cap are then screwed back on the open end of the CFV.

With a “red CFV” that operates at 1.5 bar (21 psi) the output will be 580 ml/minute and 30 ml/m² at the same spraying speed (see page 27).

7. Procedures after spraying

Advise the occupants to stay outside until the spray is dry.



Instruct the householder to sweep or mop the floor before children or pets are allowed to re-enter.



Instruct the householder not to clean the sprayed surfaces



8. Disposal of remains of insecticides and empty packaging

At the end of the day's work, put the washings from the sprayer into pit latrines, if available, or into pits dug especially for this purpose and away from sources of drinking water. Dilute any insecticide with more water before putting into pits.

Note: It is advisable to prepare only sufficient insecticide to avoid disposal of remaining.



Never pour the remaining insecticide into rivers, pools or drinking water sources.

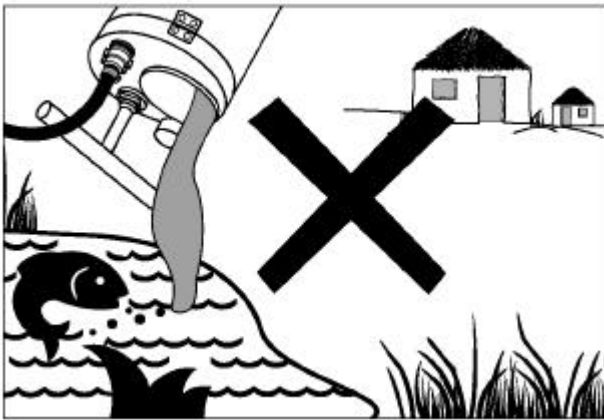

All empty packaging should be returned to the supervisor for SAFE disposal.

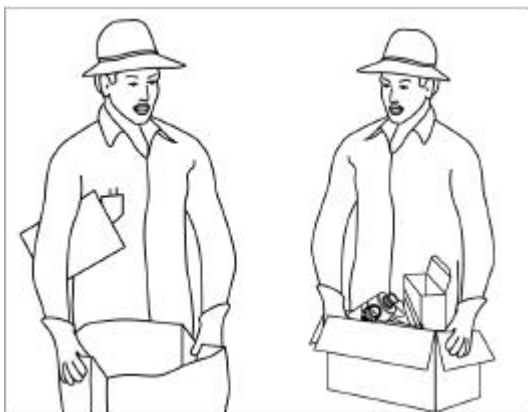

Never re-use empty insecticide containers.



Empty insecticide containers should NOT be burned or buried.



9. Maintenance of equipment

After completing the day's work, de-pressurize the tank and empty any remaining insecticide, following the instructions given in the previous section. Clean the tank as explained below:

1. De-pressurize the tank.

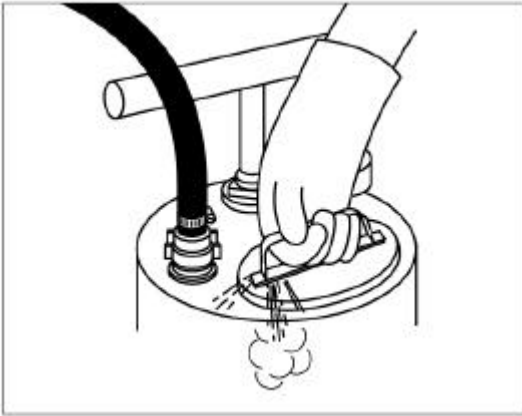

2. Fill the tank half-full with clean water.

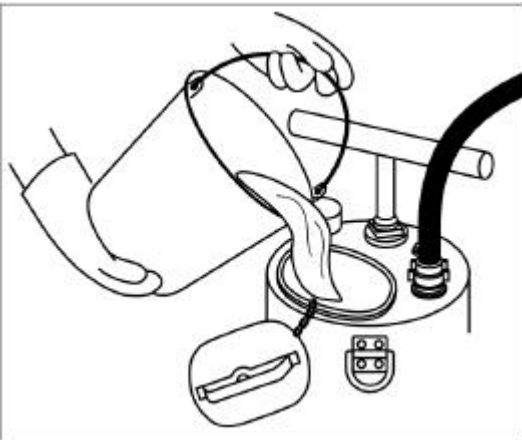

3. Replace the lid.

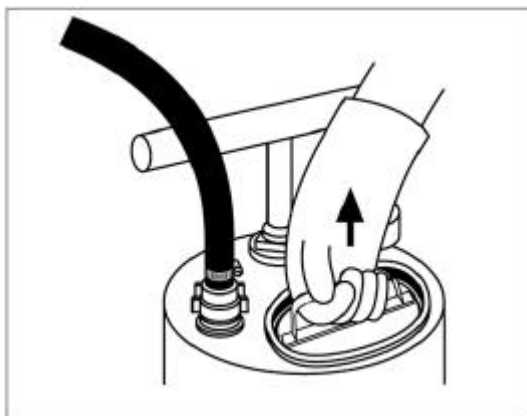

4. Shake the tank so all inside surfaces are washed.

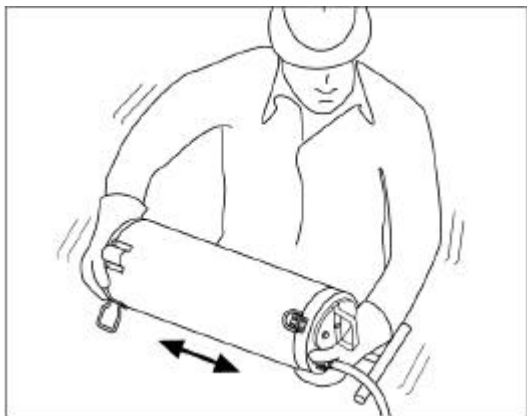

5. Pump up to 3 bar (=43.5 psi) pressure.

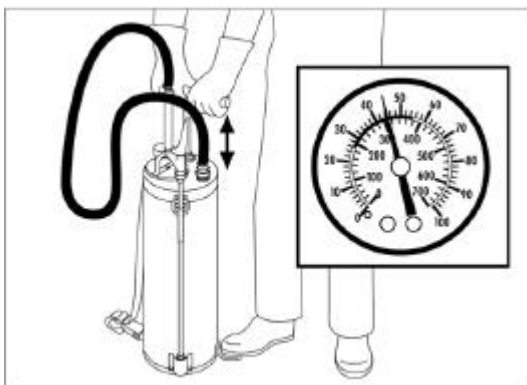

6. Spray water through nozzle.

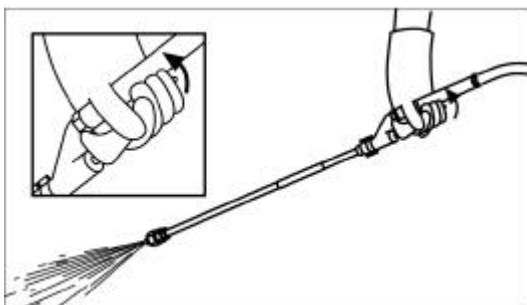

7. De-pressurize the tank and pour out any remaining water into pit latrines or into a pit away from sources of water.

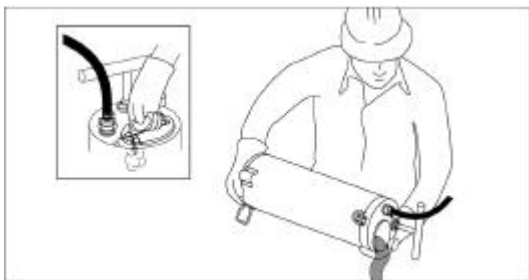

8. Unscrew trigger on/off valve handle and check and clean the strainer.

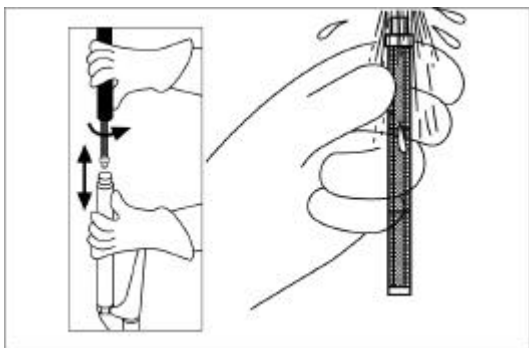

9. Reassemble the trigger on/off valve.

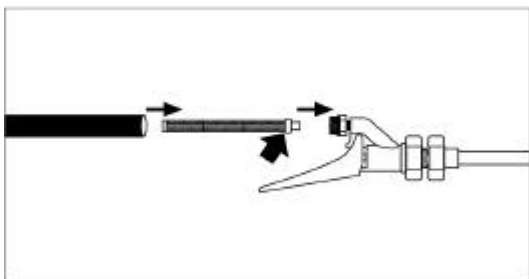

10. Remove the nozzle tip and wash.



11. Refit the nozzle

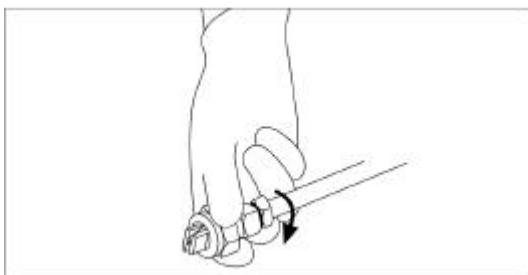

12. Clean outside of tank.



13. With lid open, turn tank upside down, open the on/off valve and let all the water drain out of the hose and lance.

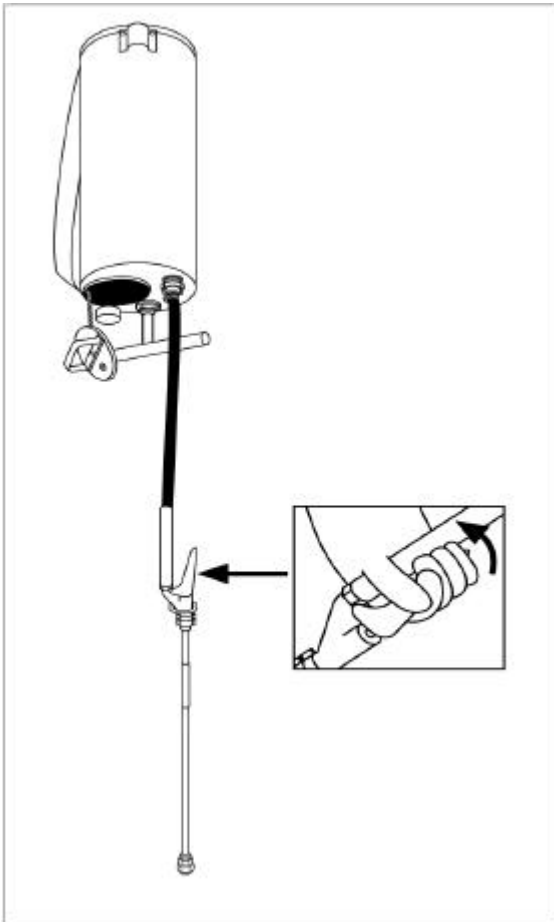

Ensure the lance is parked to protect nozzle when not in use.

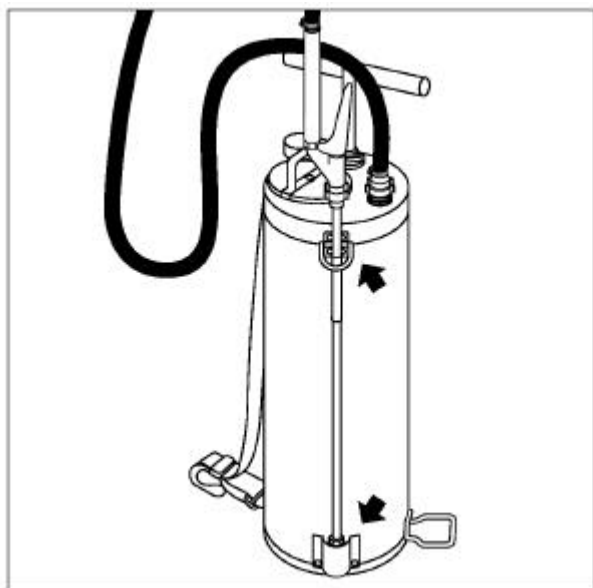

When storing the sprayer for a long period, hang it upside down with lid open to allow air circulation. Allow lance to hang from D-ring on the tank with the trigger valve kept open.

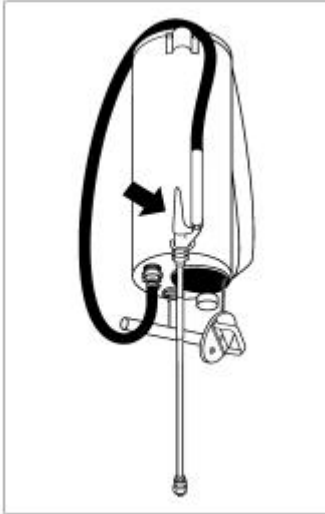

10. Trouble-shooting

If the pump fails to pressurize the tank:

1. Remove the pump plunger from the sprayer by loosening the nut holding the pump on the top of the tank
2. Insert a gloved hand into the tank and hold the pump cylinder.
3. Unscrew cap holding the pump and pull the plunger from the tank.
4. Remove the pump cylinder from inside the tank.

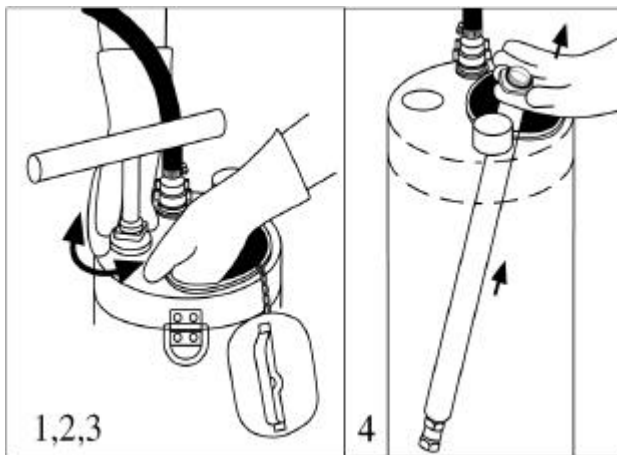

5. If leather pump plunger cup is dry, soften it by rubbing in some clean engine oil. If it is damaged and needs replacing, unscrew the disc holding the plunger cup and replace.



6. Reassemble the pump; check the gasket is in place on the pump cylinder, then hold the pump cylinder inside the tank, with threaded part through opening in the top of the tank; insert the pump plunger into the cylinder, turn the plunger cap counter-clockwise on the cylinder to ensure the threads match, then screw the cap on and tighten.

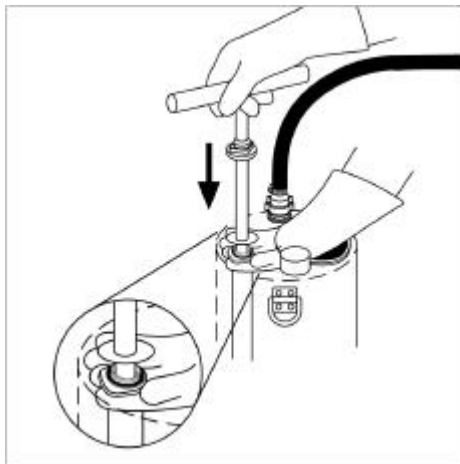

If the tank fails to hold pressure:

- Check the rubber seal on the lid and replace if necessary.

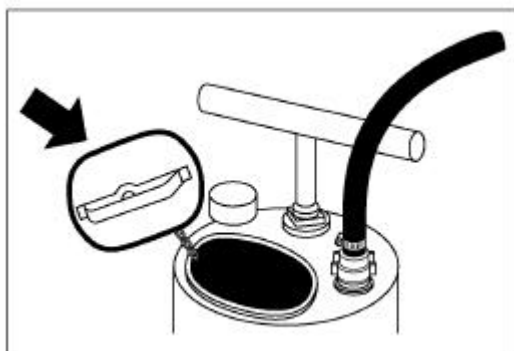

- Check the hose connections to the tank are tight.

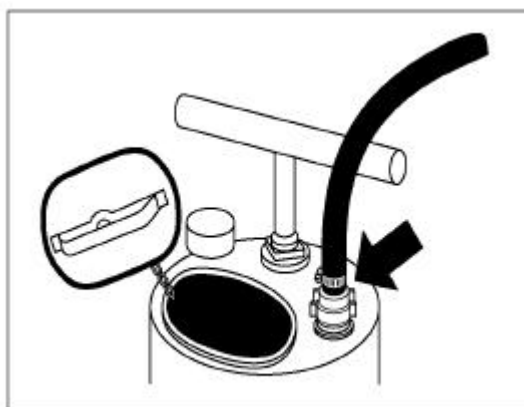

If the sprayer does not shut off:

Check the trigger on/off valve.

1. De-pressurize the tank.

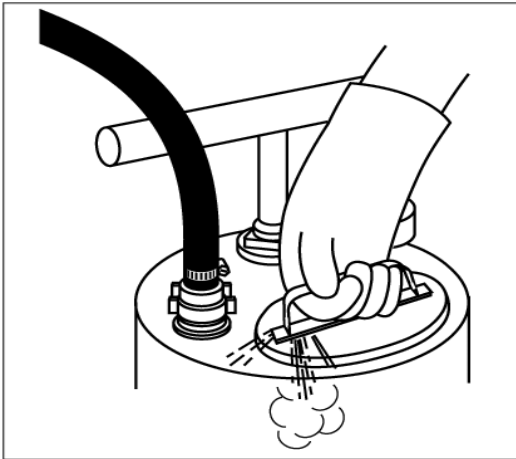

2. Disconnect the trigger valve from the hose.

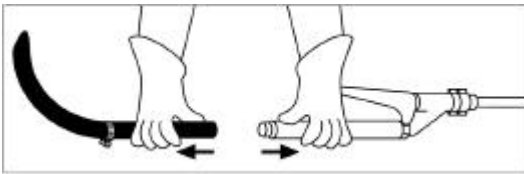

3. Take the filter out of the handle.

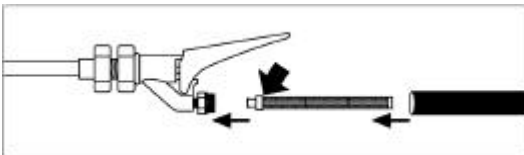

4. Unscrew the remaining assembly to see if spring and washers need to be cleaned or replaced.

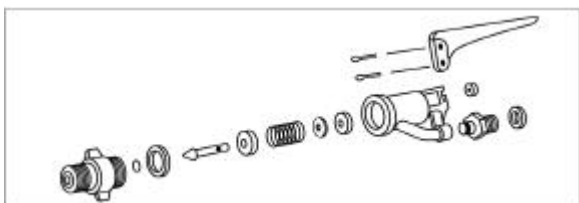

11. Preparation of insecticide spray

The amount of formulated insecticide required for the preparation of an insecticide spray is based on the average discharge rate of the sprayer and speed of application. At a working pressure of between 25 and 55 psi and the standard speed of application (see page 27), the application rate will be 40 ml/m². This means that 8 litres (8,000 ml) of spray suspension can be sprayed to 200 m² (*calculation: 8,000 ml / 40 ml/m² = 200 m²*).

Example 1: A target application of 2 g of active ingredient/m² requires 400 g of active ingredient in the tank (*calculation: 2 g/m² x 200 m² = 400 g*). Therefore for a formulated insecticide of 50% wettable powder, 800 g of the formulated product should be mixed with water to give 8 litres of suspension (*calculation: 400 g / 0.50 = 800 g*).

Example 2: A target application of 0.050 g of active ingredient/m² requires 10 g of active ingredient in the tank (*calculation: 0.050 g/m² x 200 m² = 10 g*). Therefore for a formulated insecticide of 2.5% wettable powder, 400 g of the formulated product should be mixed with water to give 8 litres of suspension. (*calculation: 10 g / 0.025 = 400*).

Note 1: The amount of active ingredient (a.i.) in liquid formulations (e.g. EC, SC) may be expressed as weight/weight (w/w) or weight/volume (w/v). In the latter case, the calculations proceed as in the previous examples. However, in the case of w/w, consult the label carefully, it will also give the amount of active ingredient per litre. Convert this to percent before proceeding with the calculations, as stated above. For example, if the label indicates that the formulation is 8% w/w, but also indicates that it contains 100 g a.i./L, convert 100 g/L to percent (*Calculation: 100 g / 1000 ml = 10%*).

Note 2: In some countries spray pumps of 10 L capacity are used. With such tank capacity the spray suspension covers 250 m^2 when applied at 40 ml/m^2 .

Note 3: With the “red CFV” (see page 28) the application rate will be 30 ml/m^2 and, therefore, 8 litres of spray suspension can be sprayed to 266 m^2 , at the same spraying speed (*calculation* $8,000 \text{ ml} / 30 \text{ ml/m}^2 = 266 \text{ m}^2$). A target application of 2 g of active ingredient/ m^2 requires 532 g of active ingredient in the tank (*calculation*: $2 \text{ g} \times 266 \text{ m}^2 = 532 \text{ g}$). For a formulated insecticide of 50% wettable powder, therefore, 1064 g of the formulated product should be mixed with water to give 8 litres of suspension (*calculation*: $532 \text{ g} / 0.50 = 1064 \text{ g}$).